

CONTENTS

SECTION 1—WASP SETUP.....	5
SECTION 1.1—WASP	6
ZONE OF NEUTRALITY: LEFT AND RIGHT CHANNEL	6
SPEAKER PLACEMENT VERSUS LISTENING POSITION	9
SPEAKER ORIENTATION.....	9
SECTION 2—UNCRATING ALEXIA V.....	13
SECTION 2.1—UNCRATING ALEXIA V.....	14
INITIAL CHECK.....	14
UNCRATING THE WOOFER MODULE	14
UNCRATING THE UPPER ARRAY	15
SECTION 3—ASSEMBLING ALEXIA V.....	19
SECTION 3.1—INITIAL ASSEMBLY.....	20
PREPARATION	20
UPPER ARRAY ASSEMBLY	20

2 ALEXIA V INSTALLATION AND CARE GUIDE

SECTION 3.2—ALEXIA V PROPAGATION DELAY ADJUSTMENT.....	21
LISTENING POSITION.....	21
ALIGNMENT PROCEDURE	21
SECTION 3.3—MOUNTING THE UPPER ARRAY	24
MATERIALS REQUIRED	24
INSTALL THE UPPER ARRAY AS FOLLOWS	25
SECTION 3.4—TWEETER MODULE PROPAGATION DELAY.....	26
SECTION 3.5—UMBILICAL CONNECTIONS	27
SECTION 4—FINAL SETUP.....	29
SECTION 4.1—SPIKING ALEXIA V	30
WILSON AUDIO ACOUSTIC DIODE “SPIKE” ASSEMBLY.....	30
INSTALLATION PROCEDURE	31
SECTION 4.2—LEVELING ALEXIA V	32
SECTION 4.3—REMOVING THE PROTECTIVE FILM	33
SECTION 4.4—RESISTORS.....	33
MIDRANGE AND TWEETER RESISTORS	34

WOOFER DAMPING RESISTOR 34

SECTION 5—SPECIFICATIONS 37

 SECTION 5.1—SPECIFICATIONS 38

 SECTION 5.2—GRAPHICAL DIMENSIONS 39

 SECTION 5.3—ALEXIA V PHASE CURVE 40

 SECTION 5.4—ALEXIA V IMPEDANCE CURVE 41

SECTION 6—TIME ALIGNMENT CHARTS 43

 SECTION 6.1—TIME ALIGNMENT CHARTS 44

SECTION 7—WARRANTY 47

 SECTION 7.1—WARRANTY DETAILS 48

 LIMITED WARRANTY 48

 CONDITIONS 48

 REMEDY 48

 WARRANTY LIMITED TO ORIGINAL PURCHASER 49

 DEMONSTRATION EQUIPMENT 49

 MISCELLANEOUS 49

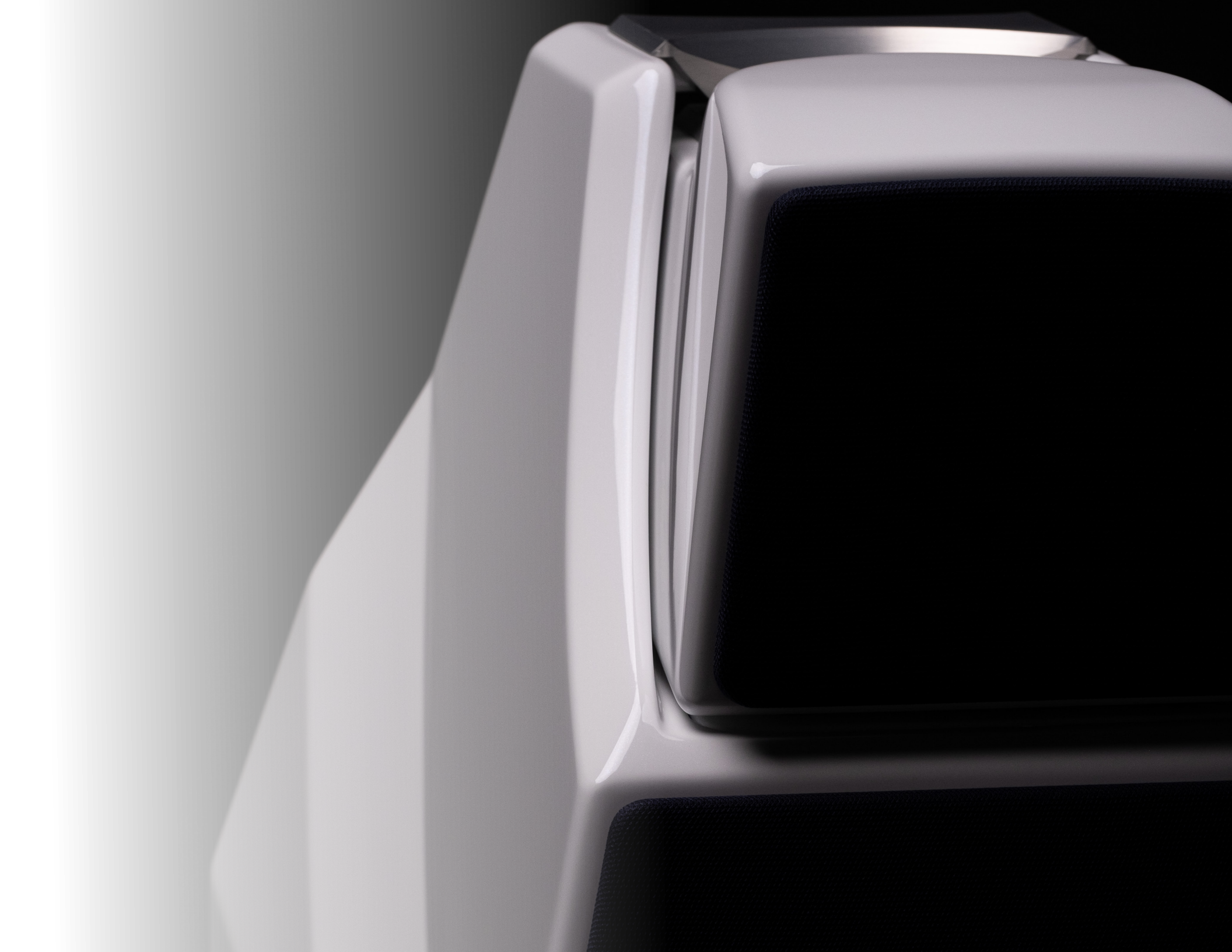

SECTION 1—WASP SETUP

SECTION 1.1—WASP

An instructional video outlining the Wilson Audio Setup Procedure (WASP) can be found here: www.wilsonaudio.com/wasp. The proper positioning of your new Alexia V within your room is critical in order to extract its formidable performance envelope. When carefully followed, the WASP has proven to be the most effective method for setting up Wilson Audio loudspeakers. Your authorized Wilson Audio Dealer is trained in this process, and is the best resource for you to ensure your loudspeakers are set up properly.

Viewing the video is the best way to learn how to properly employ WASP, but we have also included an outline of it here.

Zone of Neutrality: Left and Right Channel

The “Zone of Neutrality” is an area in your room where the speakers will sound most natural. This location is where the speakers interact the least with adjacent room boundaries. It is important to have a clear working space while determining the Zone of Neutrality.

The following is a simple method to locate the Zone of Neutrality within your listening environment:

1. Stand against the wall BEHIND the location where you intend to position your loudspeakers. Speaking in a moderately loud voice and at a constant volume, project your voice out into the room. Your voice will have an overly heavy, “chesty” quality because of your proximity to the rear wall.
2. While speaking, slowly move out into the room, progressing in a direction parallel to the sidewall. It is helpful to have another listener seated in the listening position to assist you during this process. Listen to how your voice “frees up” from the added bass



WASP VIDEO

energy imparted by the rear wall boundary. Also notice that your voice is quite spatially diffuse (to your assistant, your voice will sound spatially large and difficult to localize) as you begin to ease away from the rear wall.

3. At some point during your progression forward into the room, you will observe a sonic transition in your voice; it will sound more tonally correct and less spatially diffuse (your assistant can now precisely localize the exact origin of your voice). When you hear this transition, you have entered the inner edge of the Zone of Neutrality. Place a piece of tape on the floor to mark this location. Although it will vary from room to room, in most rooms the zone begins between two and a half to three feet from the rear wall.
4. Continue to walk slowly away from the rear wall. After some distance, usually one to two feet past the first piece of tape, you will begin to hear your voice lose focus and appear to reflect (echo) in front of you. This is caused by the return of the room's boundary contribution; your voice is now interacting with the opposite wall. At the point where you begin to hear the reflected sound of your voice, you have reached the outer edge of the Zone of Neutrality. Place a piece of tape on the floor and mark this location. The distance between the "inner" and "outer" edge tape marks is usually between eight inches (for small, interactive rooms) and three feet (for large, more neutral rooms).
5. Now position yourself against the side wall perpendicular to the intended speaker location. Stand between the two tape marks. Using the same procedure as above, begin moving into the room toward the opposite sidewall, progressing between the two pieces of tape. As above, listen for the point in the room where your voice transitions from bass-heavy and diffuse to neutral. Mark this point with tape. Continue your progression until there is an obvious interaction with the opposite wall in front of you and mark this point with tape. The four pieces of tape now form a rectangle that establishes the Zone of Neutrality for the loudspeaker to be installed on that side of the room. Using the four marks as your guide, tape an outline to define the boundaries of the rectangle.

8 ALEXIA V INSTALLATION AND CARE GUIDE



When carefully followed, the WASP has proven to be the most effective method for setting up Wilson Audio loudspeakers.

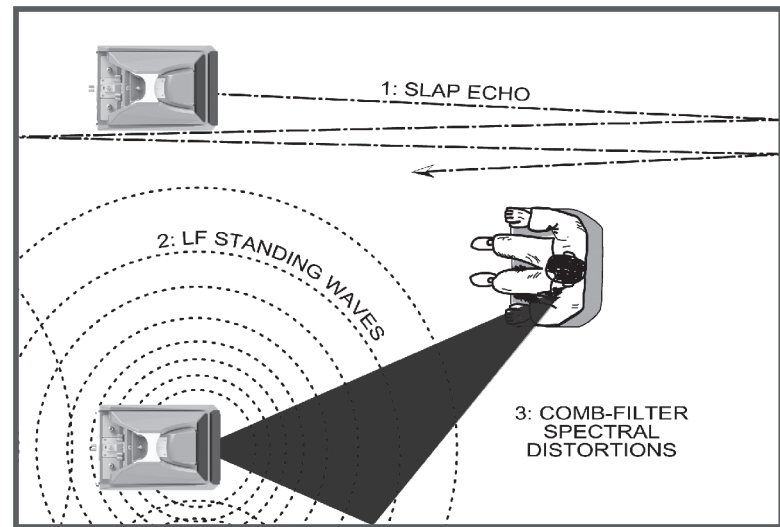

6. Repeat this process for each speaker location individually. These are your Zones of Neutrality, one for each channel.

Theoretically, the Zone of Neutrality for any room runs like a path, parallel to the walls all around the room. Adjacent to very large windows and open doors, the outer edge of the Zone of Neutrality moves closer to the wall and becomes wider. If you were to extend the inner and outer boundaries of the Zone for the sidewalls and the front wall (behind the speakers), they would intersect.

Speaker Placement Versus Listening Position

The location of your listening position is as important as the careful setup of your Wilson Audio loudspeakers. The listening position should ideally be no more than 1.1 to 1.25 times the distance between the tweeters on each speaker. Therefore, in a long, rectangular room of 12' x 18', if the speaker tweeters are going to be 9' apart, you should be sitting 9'11" to 11'3" from the speaker. This would be more than halfway down the long axis of the room.

Many people place the speakers on one end and sit at the other end of the room. This approach will not yield the finest sound. Carefully consider your listening position. Our experience has shown that any listening position that places your head closer than 14" from a wall will diminish the sonic results of your listening due to the deleterious effects of boundary interaction.

Speaker Orientation

Speaker placement and orientation are two of the most important considerations in obtaining superior sound. The first thing you need to do is eliminate the sidewalls as a sonic influence in your system. Speakers placed too close to the sidewalls will suffer from a strong primary reflection. This can cause out-of-phase cancellations, or comb

filtering, which will cancel some frequencies and change the tonal balance of the music. Adhering to the Wilson Audio Setup Procedure outlined in this section is the best method with which to position your loudspeakers.

A very important aspect of speaker placement is how far from the back wall to place the speakers. The closer a loudspeaker is to the back wall, the more pronounced the low bass energy and centering of the image will be. However, this comes at a definite reduction in stage size and bloom as well as a deterioration of upper bass quality. You must find the proper balance of these two factors, but remember, if you are partial to bass response or air and bloom, do not overcompensate your adjustments to maximize these effects. Overcompensated systems are sometimes pleasing in the short-term, but long-term satisfaction is always achieved through proper balance.

To make correct in-home set up of the Alexia V possible without test equipment, Wilson Audio has measured the correct geometric time domain alignment for different distance/ear height combinations. By measuring the distance from the speaker to your ear (measured on the floor from the bottom/front of the woofer to directly below the ear canal) when seated in the listening position, as well as height of the listener's ear (the distance from the floor to the center of the ear canal), you will be able to align the system for your listening position.

UPPER ARRAY

1. Remove screws as shown in image.

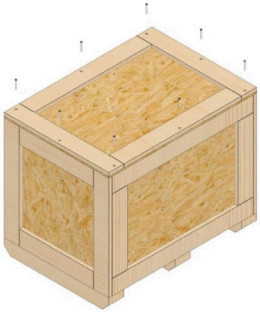

2. Remove and set aside crate lid.



3. Remove tool kit, spike kit, and foam piece.

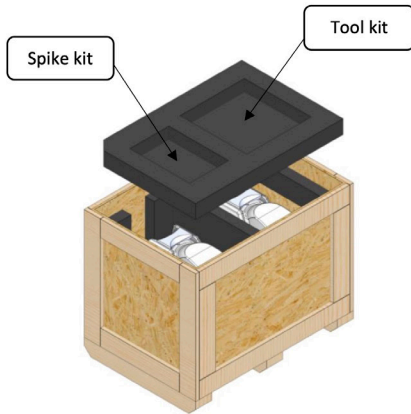

4. Remove upper modules, one at a time, and set aside. Use caution to prevent damage.

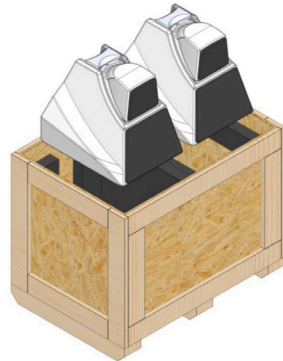

WOOFER

1. Remove screws as shown in image.

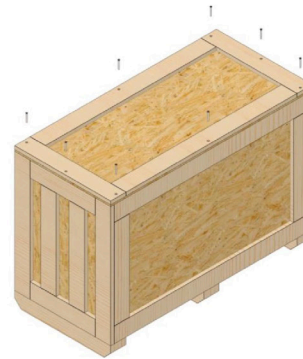

2. Remove and set aside crate lid and foam pieces.

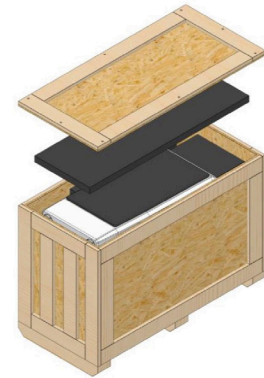

3. With help, lift crate up so that woofer is resting on casters. Use caution to prevent damage.

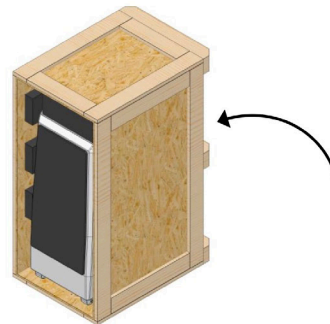

4. With help, roll woofer out of crate. Use caution to prevent damage.

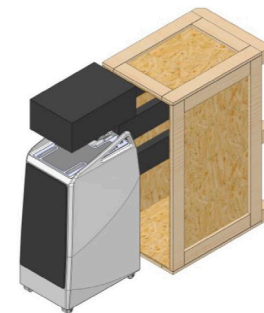

SECTION 2—UNCRATING ALEXIA V

Note: You will have two Upper Array enclosures as well as two Woofer Module enclosures to unpack. The two modules for each of the channels will need to be separated into right and left channels. Clear out two spaces in your room, one for your left and one for your right channels. For channel matching, place the ODD numbered modules in the LEFT channel position and the EVEN numbered modules in the RIGHT channel position.

SECTION 2.1—UNCRATING ALEXIA V

Note: To avoid damaging the Alexia V's painted surface. Please remove any jewelry such as rings, watches, necklaces, and bracelets during this process along with covering belt buckles and zippers.

Initial Check

The Alexia V is shipped in three wooden crates (*see page 12 for visual guide*). Upon receiving these crates, please check their condition. If any of the crates are damaged, please report it to the shipping company immediately for insurance verification.

The following items are recommended for this procedure:

- Electric Screwdriver
- Phillips Head Bit
- Something to cut the band around crates

Uncrating the Woofer Module

A minimum of two strong adults is required to set up the Alexia V. Locate the two largest crates labeled "Alexia V Lower." These contain the woofer enclosures and are the first components of the system to unpack.

1. Cut the band wrapped around the crate. With the crate lid facing up, unscrew the wood screws securing the lid. Remove the lid.
2. Carefully lift the crate upright so that the Woofer Module is now vertical. With the Woofer Module's bottom toward the floor, reach in and gently roll the Woofer Module out of the crate, carefully, so as not to hit the Woofer Module on the crate and scratch the paint.
3. Place the Woofer Module with an odd serial number on the left side of the room and the Woofer Module with an even serial number on the right side of the room.

Note: These two Woofer Modules are very heavy and care should be taken to prevent injury. Roll the Woofer Module with drivers facing forward for the best stability.

Uncrating the Upper Array

The Upper Arrays are contained in a single crate labeled "Alexia V Uppers." Unpack the enclosures using the following procedure:

4. Cut the band wrapped around the crate. With the crate lid facing up, unscrew the wood screws securing the lid. Remove the lid.
5. The Upper Array crate contains this Installation and Care Guide, the Tool Kit, and the Spike Kit. Remove these.
6. Make sure the thumb bolt that secures the Tweeter Module is tight before moving.
7. When removing the Upper Arrays, take care so as not to hit the modules on the crate and scratch the paint. Using the small shelf on the rear of the module, tilt it so there is

16 ALEXIA V INSTALLATION AND CARE GUIDE

You will be using tools and parts in these kits throughout the installation process. Keep the Alexia V Tool Kit and Spike Kit at hand.

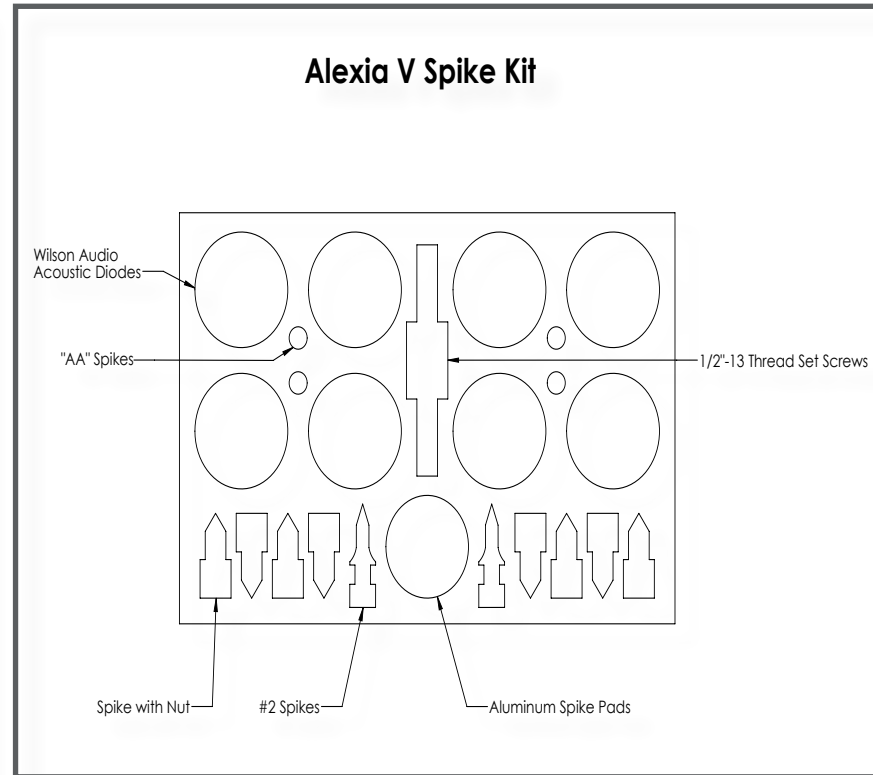
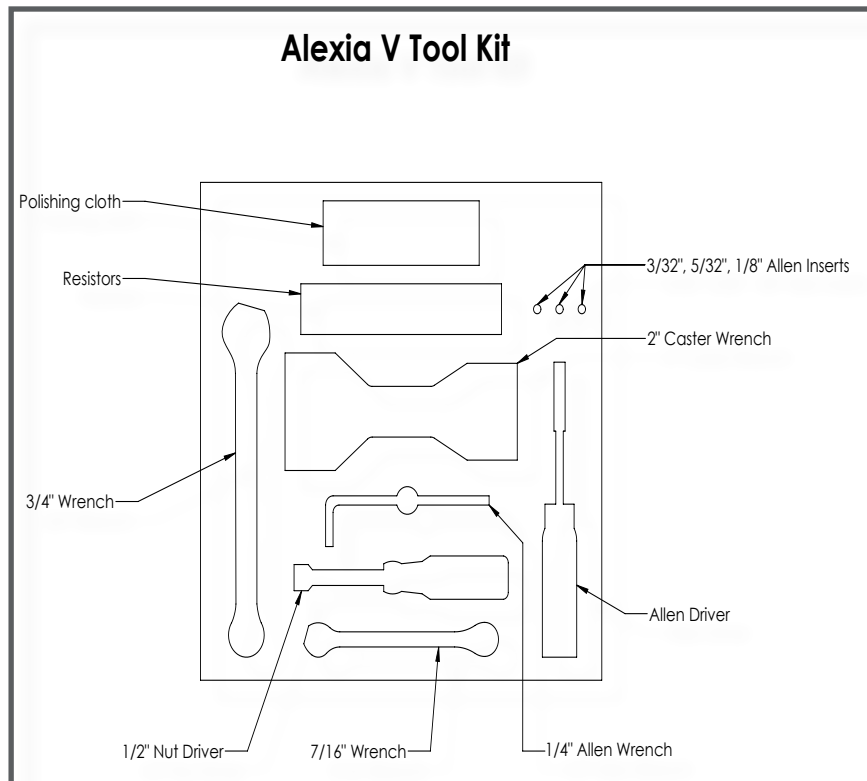

access to the bottom side. Slide the other hand under the Upper Array for support, and carefully lift the enclosure out of the crate.

8. The cloth grilles are attached to the enclosures. Detach the grilles from the enclosure and remove the protective plastic covering the grille.
9. Place the Upper Array with an odd serial number on the left side of the room and the Upper Array with an even serial number on the right side of the room with the drivers facing the wall (to protect the drivers while uncrating).

Note: After the system is set up, keep the shipping crates for future shipping needs.

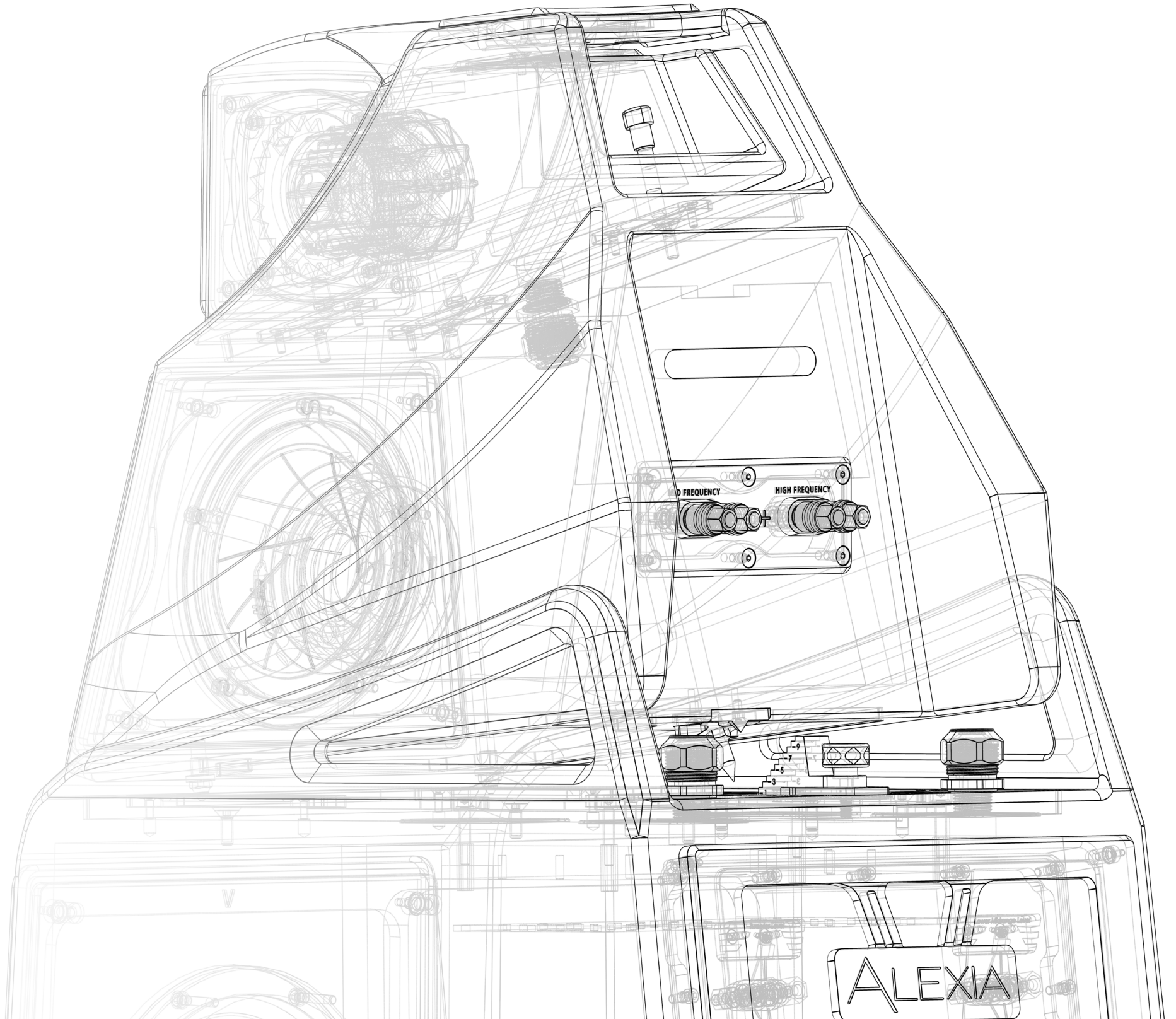

SECTION 3—ASSEMBLING ALEXIA V

Note: Before setting up Alexia V, please carefully study Section 1 and/or watch the WASP video. They provide valuable information on determining the ideal room location for your speakers.

SECTION 3.1—INITIAL ASSEMBLY

Preparation

You will need the following items:

- Supplied Tool & Spike Kits
- Tape Measure
- Time Alignment Charts (*see Section 6*)
- Known Listening Position
- Masking Tape & Pen

Take a moment to familiarize yourself with the top of the Woofer Module. A complete set of Time Alignment Charts is located in Section 6.

Upper Array Assembly

The Upper Array uses “AA” spikes on the front of the enclosure (*see graphic above*) and the built-in spike/receptical found at the bottom rear of the enclosure. In some installation positions the Time Alignment Charts will indicate a need to thread the #2 spike into the spike receptical found at the bottom rear of the enclosure. The spikes rotate the Upper Array to a scribed position as a part of the Alexia V’s propagation delay adjustment and correction. Shorter “AA” spikes are always installed in the front two positions (the threaded holes located near the bottom front of the enclosure). The spike-type is

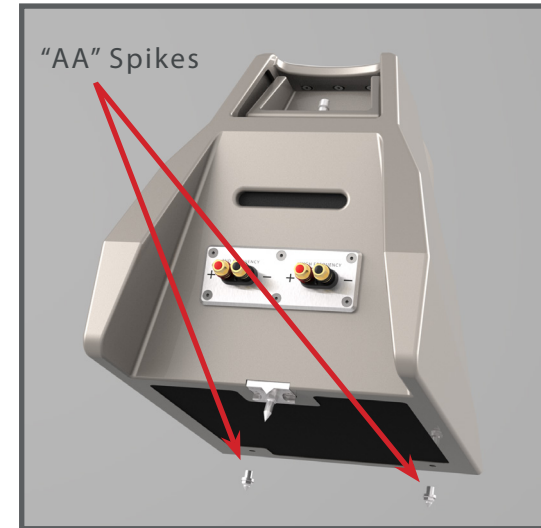

stamped in the round top of the spike. The spikes should be screwed in all the way, until they are hand tight. Use the 7/16" Wrench to tighten the spike to the enclosure. **Do not over tighten spikes.**

SECTION 3.2—ALEXIA V PROPAGATION DELAY ADJUSTMENT

Listening Position

The Alexia V time alignment design and unique architecture accounts for different listening distances (away from the speakers) and listening ear heights (measured distances from the floor to your ear). For each distance/ear height combination there is a custom alignment geometry.

To make correct in-home set up of the Alexia V possible without test equipment, Wilson Audio has provided the correct geometric time domain alignment for different distance/ear height combinations. This information can be found in the Time Alignment Charts in Section 6. By measuring the distance from the speaker to your ear when seated in the listening position (measured on the floor from the bottom/front of the woofer to directly below the ear canal), as well as height of the listener's ear (the distance from the floor to the center of the ear canal while comfortably sitting), you will be able to align the Alexia V so that it is extremely accurate in the time domain for your personalized installation.

Alignment Procedure

Locate the Time Alignment Charts in Section 6. These tables contain critical information that will guide you to position the Upper Arrays for optimized propagation delay accuracy.

The rear of the Upper Array assembly rests on a specific step on the Alignment Block. The Time Alignment Charts also contain information on the front-to-back alignment of the Upper Array. The

position of the Upper Array is facilitated by the Alignment Block Steps (rotation) as well as the front-to-back location of the Upper Array—determined by the position of the Alignment Block. The position is designated by the engraved numbers in the Alignment Block mounting plate. Position the Alignment Block by aligning the rear of the Alignment Block to the number engraved on the plate as indicated in the chart in Section 6.

There are also two spike configurations, the use of which are determined by the distance/ear relationship of the installation. The two rear spike configurations are: no spike, or a #2 spike. The table in Section 6 also contains information on the appropriate length spike to be used in the rear of the Upper Array.

The Tweeter module's upper alignment plate features detents that correspond to a spike built into the front of the upper cross member "bridge" located above the tweeter module, the specific location of which determines the propagation delay position of the tweeter module within the Upper Array. The alignment plate contains numbered detents. The alignment tables in Section 6 contain the information for positioning the tweeter module in the array, determined by the detent in which the cross member's spike rests.

Determine the alignment of each Upper Array and the Tweeter Module as follows. Repeat each step of this procedure on the left and right channels simultaneously.

1. Refer to the Time Alignment Charts from Section 6 in this manual and place them close by for easy reference.
2. Make sure that you are in your intended listening position.
3. While sitting comfortably, have someone measure your ear height from

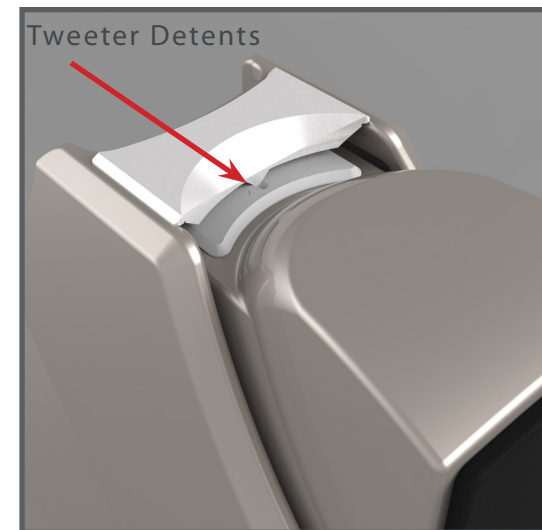

the floor directly below your ear canal. You should be relaxed in your chair, as you would be when listening to music.

4. Now measure the distance from the point on the floor below your ear to the center point between the spikes at the base of the loudspeaker (*see image on page 24*).
5. Refer to the Time Alignment Charts (*see Section 6*) and locate the corresponding ear height and listening distance for each module. There are four charts for the Upper Array. The first: “Upper Array Alignment Block Position” determining the Alignment Block’s front-to-back location. The second is the table: “Upper Array Alignment Block Step” determining where the rear spike on the bottom of the mid module will rest. The third table: “Midrange Spike Length” determines whether or not there is a spike installed into the rear of the module. The fourth table: “Tweeter Detent Position” specifies the detent position the bridge spike will rest in on the top of the tweeter module.
6. Make a mark on the chart labeled “Upper Array Alignment Block Position” indicating the resting position for the alignment block using the back of the block as a reference.
7. Make a mark on the chart labeled “Upper Array Alignment Block Step” indicating which step the rear spike on the Upper Array will rest.
8. Make a mark on the chart labeled “Midrange Spike Length” indicating the proper rear spike for the Upper Array.
9. **Note: The shortest spikes (labeled “AA”) are always used at the front of the Upper Array.**
10. Make a mark on the chart labeled “Tweeter Detent Position” indicating the detent in which the bridge spike rests.

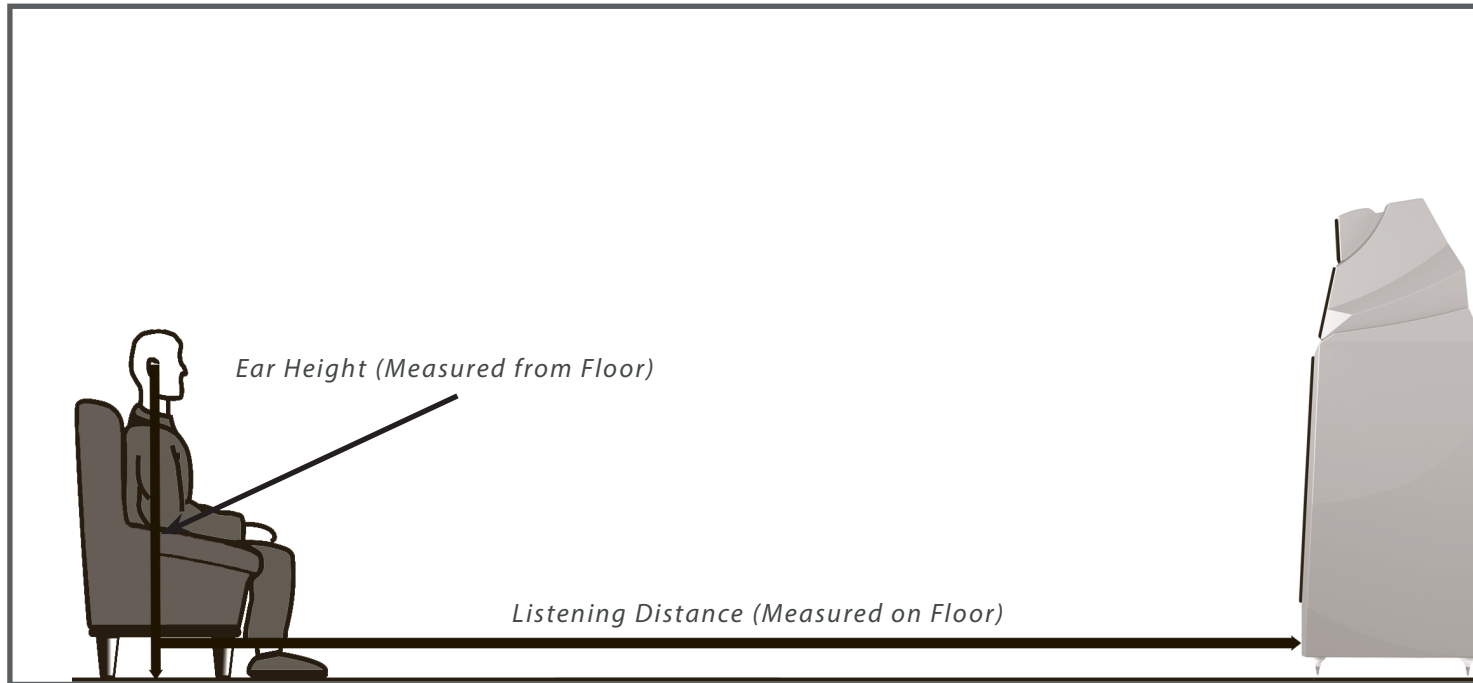

SECTION 3.3—MOUNTING THE UPPER ARRAY

Materials Required

- Correct spikes for the Upper Array.
- Reference Section 6 for the front-to-back location of each module, along with the use of the proper length of rear spike of the upper arrays. Refer to the Alexia V Time Alignment Charts and the procedure in the previous section to determine the correct Aspherical Propagation Delay spikes as necessary, the Alignment Block position, and the proper step location for the spike.

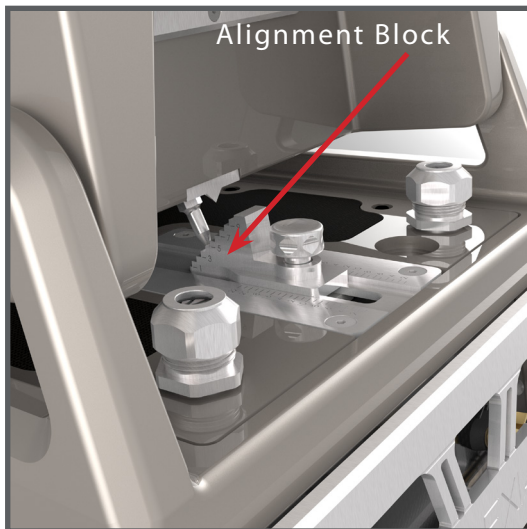
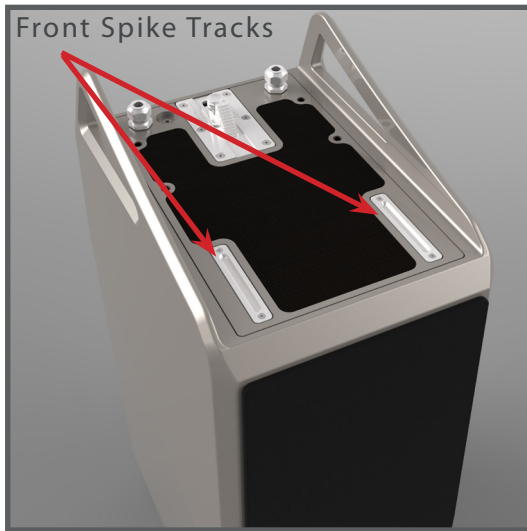

Install the Upper Array As Follows

1. Install the front pair of short (“AA” length) spikes into the bottom of each Upper Array. Use the 7/16” Wrench to tighten the spikes to the enclosure. **Do not over tighten spikes.**
2. Refer to the table labeled “Midrange Spike Length” and install the appropriate rear spike, if necessary. Use the 7/16” Wrench to tighten the spike to the enclosure. **Do not over tighten spikes.**
3. Refer to table labeled “Upper Array Alignment Block Position.” Using the rear edge of the Alignment Block as the guide, align the block to the proper front-to-back setting for the Upper Array. Once the block is in its proper position, lock it down by twisting the locking bolt (no tools needed).
4. Refer to the table labeled “Upper Array Alignment Block Step”. With the front spikes pointing down, **carefully** lower the Upper Array between the woofer blades and set the spikes down on the front spike tracks. Rest the rear spike on the step on the alignment block step indicated on the chart.

NOTE: Take caution not to scratch the painted surface with the alignment spikes as you install the Upper Array. The front bevel on the Woofer Module is particularly vulnerable.

SECTION 3.4—TWEETER MODULE PROPAGATION DELAY

Refer to Table labeled “Tweeter Detent Position.” Loosen the oval tether bolt on the rear of the tweeter module enough so that it can freely move front-to-back.

Note: When you loosen the oval tether bolt securing the Tweeter Module, support the front of the module to ensure it does not slide forward.

1. Locate the number on the tweeter alignment plate, on the upper plane of the tweeter, that corresponds to the detent indicated in the table.
2. Slide the tweeter such that the downward pointing spike of the Array bridge aligns with the appropriate numbered detent.
3. Re-tighten the oval tether bolt, ensuring the cross member spike rests in the correct detent location.

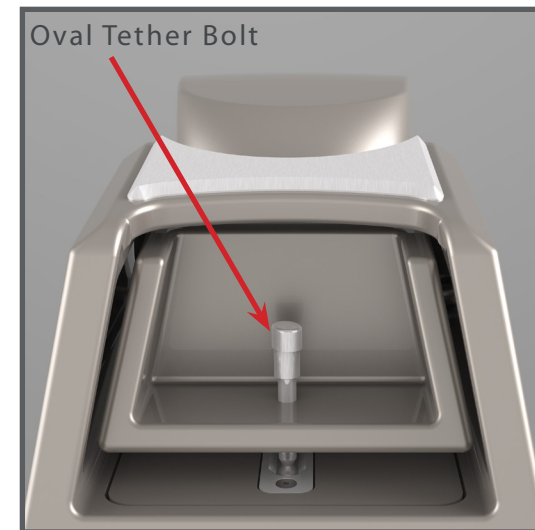

SECTION 3.5—UMBILICAL CONNECTIONS

The correct connection of the two umbilicals to the Upper Array is as follows:

1. Locate the binding post labeled “Mid Frequency.”
2. Locate the cable directly below this binding post. This cable exits the top of the Woofer Module just below the appropriate connector. Connect the RED cable to the RED (positive) terminal labeled “Mid Frequency.” Connect the BLACK lug of the cable to the BLACK (negative) terminal. Tighten binding post nut with the 1/2” Driver found in the Tool Kit. **Do not over tighten.**
3. Locate the cable directly below the binding post labeled “High Frequency.” Connect the RED cable to the RED (positive) terminal on the binding post labeled “High Frequency” on the Upper Array. Connect the BLACK cable to the BLACK (negative) terminal. Tighten binding post nut with the 1/2” Driver found in the Tool Kit. **Do not over tighten.**
4. Once the cables are connected correctly to the binding posts make sure to tighten the cable clamp hardware at the base of the cable to ensure the enclosure is sealed.
5. Using the form found on page 11 identify the best sounding location in your listening room before installing the spikes under your Woofers.



Note: Please ensure that you do not invert the polarity of the umbilicals or connect the cables to the wrong binding posts on the Alexia V. Connecting the wrong cables to the wrong binding posts will void the warranty and potentially damage the drivers.



MID FREQUENCY

HIGH FREQUENCY

+

-

+

-

ALEXIA

Upper Midrange Level

Tweeter Level

1621 161
1000
1000

1621 161
1000
1000

SECTION 4—FINAL SETUP

SECTION 4.1—SPIKING ALEXIA V

Your Dealer is trained in the art and science of the Wilson Audio Setup Procedure (WASP) outlined in Section 1. Before the spike/diode assemblies are attached to the bottom of Alexia V, the set up and fine tuning of your loudspeaker should be completed. Before spiking Alexia V, use masking tape to carefully mark their location.

Wilson Audio Acoustic Diode “Spike” Assembly

- Gather the threaded spikes and install the nut to about one thread from the unthreaded point. This will allow for greater movement when leveling the loudspeaker later.
- Screw the spike/nut combo into the diode housing until the nut is against the diode. Be careful that the nut does not turn while inserting and threading spikes into the diode.

Note: Do not tighten the nut against the diode yet. You will need to unscrew them when you level the Alexia V later.

- Place the set screw into the other end of the diode with the Allen head toward the spike. This will ensure that, if for any reason you have to remove your Alexia V spikes, you will be able to withdraw the set screw safely using the supplied Allen wrench. Screw the set screw into the diode until it stops turning.
- Place the Acoustic Diode assemblies out of the traffic pattern until they are needed during the installation.



WILSON AUDIO ACOUSTIC DIODE

Materials Required

- 8 Assembled Wilson Audio Acoustic Diodes
- Swivel Caster Wrench
- Masking Tape

Note: Be very careful not to cross-thread the spikes. The base of the Alexia V is made of “X” material and can be cross-threaded if spikes are installed at an angle.

Note: This is a two person job. Do not attempt this by yourself. The Alexia V is heavy and may seriously injure someone if tipped over.

Note: An assistant should stand to the rear of the Alexia V to steady it.

Installation Procedure

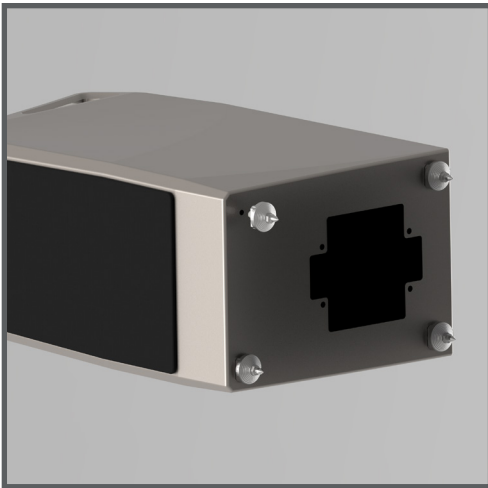

1. Take care to mark the exact location of the Alexia Vs with masking tape to ensure the speakers can be returned to their exact set up position.
2. If leaning the Alexia V to the side safely is not an option, remove the Upper Array from the Woofer Module. Lay a furniture pad or soft blanket adjacent to the Woofer Module to protect the paint. Carefully lay the Woofer Module on its side.
3. Using the caster wrench, remove the casters.
4. Insert the Acoustic Diode assemblies into the four holes located on the bottom of each Woofer Module. Tighten until the top surface of the Acoustic Diode touches the bottom surface of the “X” material plate on the bottom of the Woofer Enclosure.

Hand tighten only!

5. Taking care to observe the location of the Woofer Module relative to the masking tape used during the WASP documentation, return the Alexia V Woofer Module to the precise location marked on the ground in an upright position.
6. Re-install the Upper Array atop the Woofer Module.

SECTION 4.2—LEVELING ALEXIA V

1. Alexia V comes equipped with a built-in bubble level found on the top of the Woofer Module. Look at that bubble level and determine if the Alexia V is level or which side of the enclosure is lower than the rest making the enclosure uneven.
2. To find out which spike is lowest, grasp the Alexia V enclosure and gently rock it back and forth. This will identify the spike that is out of level from the other three.
3. Adjust the Acoustic Diodes spike/nuts shorter and/or longer until the bubble shows the speaker is level.
4. You may rotate the spike tips in place by using the supplied 7/16" wrench and tightening the nut with 3/4" wrench when finished leveling. **Note: All the nuts should be snug when finished leveling to get the best performance from the Acoustic Diodes. Do not over-tighten.**
5. Repeat process on the other loudspeaker.

SECTION 4.3—REMOVING THE PROTECTIVE FILM

To protect the finish of the Alexia V during final manufacture, shipment, and setup in your listening room, we have applied a removable layer of protective film over the paint finish. We recommend that this film be left in place until the speakers are ready to be assembled at their final location in your listening room. Once you have determined their final position, remove the film by following this procedure:

1. Ensure the speaker surface is room temperature before removing the protective film.

Note: Removing the protective film when the speaker surface is cold can damage the paint surface.

2. Slowly remove the film from the top down, large sections at a time, gently pulling the film downward and outward.

Note: Tearing the film quickly and aggressively can damage the paint.

3. Take care while removing the protective film near edges and corners to prevent paint damage in these areas.
4. The protective film should not be left on the painted surface for extended periods of time nor exposed to heat sources and/or direct sunlight.

SECTION 4.4—RESISTORS

By removing the glass cover on the upper bevel on the rear of the Woofer enclosure of your Alexia V, you may gain access to the resistor panel. These resistors serve several functions. These specialized resistors not only serve as a type of fuse to protect the Alexia V drivers, they also are used as tools for tuning the system.

Note: Only Wilson Audio replacement resistors should be used in your Alexia V. Changing the value or brand of resistor will have a potentially negative effect on the sonic performance of your loudspeakers and can void your Warranty.

Midrange and Tweeter Resistors

The midrange resistors equal 1.05 ohms (2 X 2.10 Ω in parallel). The tweeter resistors equal 2.40 ohms (2 X 4.80 Ω in parallel). Resistors provide precise level matching for the midrange and tweeter drivers correspondingly. The resistors also act as ultra-high-quality fuses which open before a driver can be damaged by excess power (i.e. power surges, blackouts, clipping, etc.).

Woofers Damping Resistor

There is a single 30.0 ohms barrel resistor for the woofer level. This resistor is preinstalled in the base of the Woofer enclosure and should not be changed by the end user.

Resistor Fine Tuning

In rare instances it may be desirable to alter the levels of the tweeter or midrange to overcome some room related tonal balance issues. Please contact your Authorized Wilson Audio Dealer for help and more information on how to proceed.

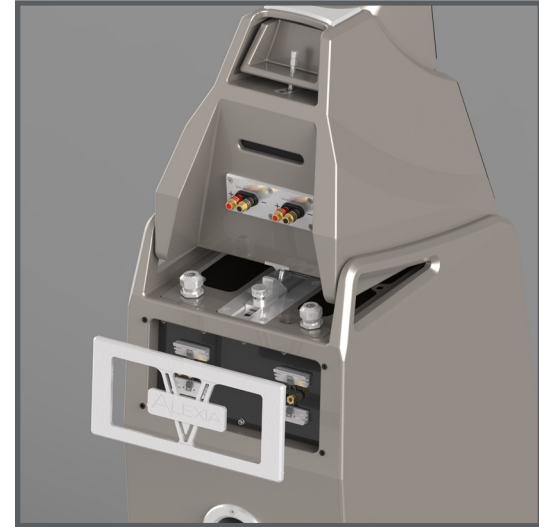

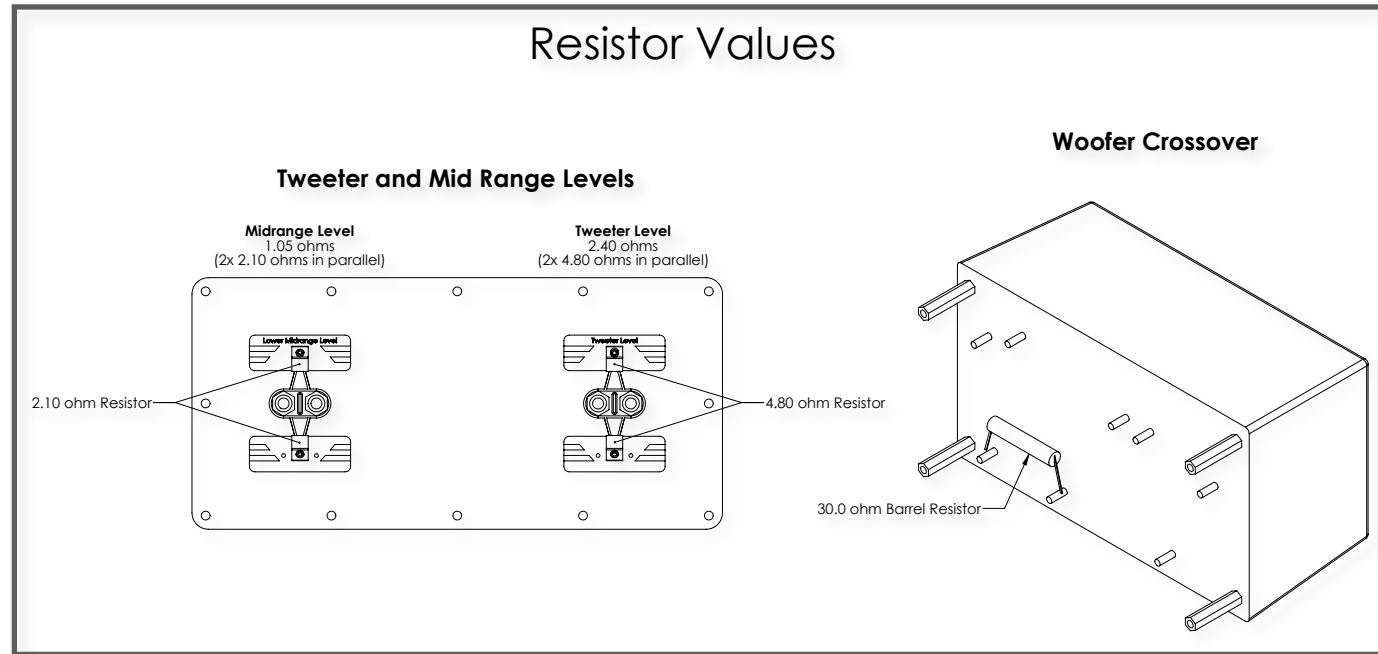

Note: These specialized resistors can be ordered from your Authorized Wilson Audio Dealer or on the Wilson Audio Online Store. Only use Wilson Audio replacement resistors in your Alexia V.

Note: If you notice the sonic qualities of your system degraded or worsen you may have resistors that are damaged. These resistors don't always "open up" like fuses and can continue to pass a signal when damaged. This is most commonly attributed to sudden surges in the system from blackouts, clipping, or "pops" associated with disconnecting cables without muting the amps. Please replace the resistors as soon as possible to bring the performance and life back into your system.

SECTION 5—SPECIFICATIONS

SECTION 5.1—SPECIFICATIONS:

Enclosure Type Woofer: Rear Ported

Enclosure Type Midrange: Rear Vented

Enclosure Type Tweeter: Sealed

Woofers: One—8 inches (20.32 cm) *Paper Pulp*

One—10 inches (25.4) *Paper Pulp*

Midrange: One—7 inch (17.78 cm) *Paper Pulp Composite*

Tweeter: One—1 inch (2.54 cm) *Doped Silk Fabric*

Sensitivity: 90 dB @ 1 Watt @ 1 meter @ 1kHz

Nominal Impedance: 4 ohms / minimum 2.59 ohms @ 84 Hz

Minimum Amplifier Power: 20 Watts per channel

Frequency Response: 19 Hz – 33 kHz +/- 3 dB *Room Average Response [RAR]*

Overall Dimensions: Height—50 ¹⁵/₁₆ inches (129.42 cm) *w/o spikes*

Width—15 ³/₄ inches (40.01 cm)

Depth—24 ³/₁₆ inches (61.41 cm)

System Weight Per Channel: 265 lb (120.20 kg)

Approximate Shipping Weight: 795 lb (360.61 kg)

SECTION 5.2—GRAPHICAL DIMENSIONS

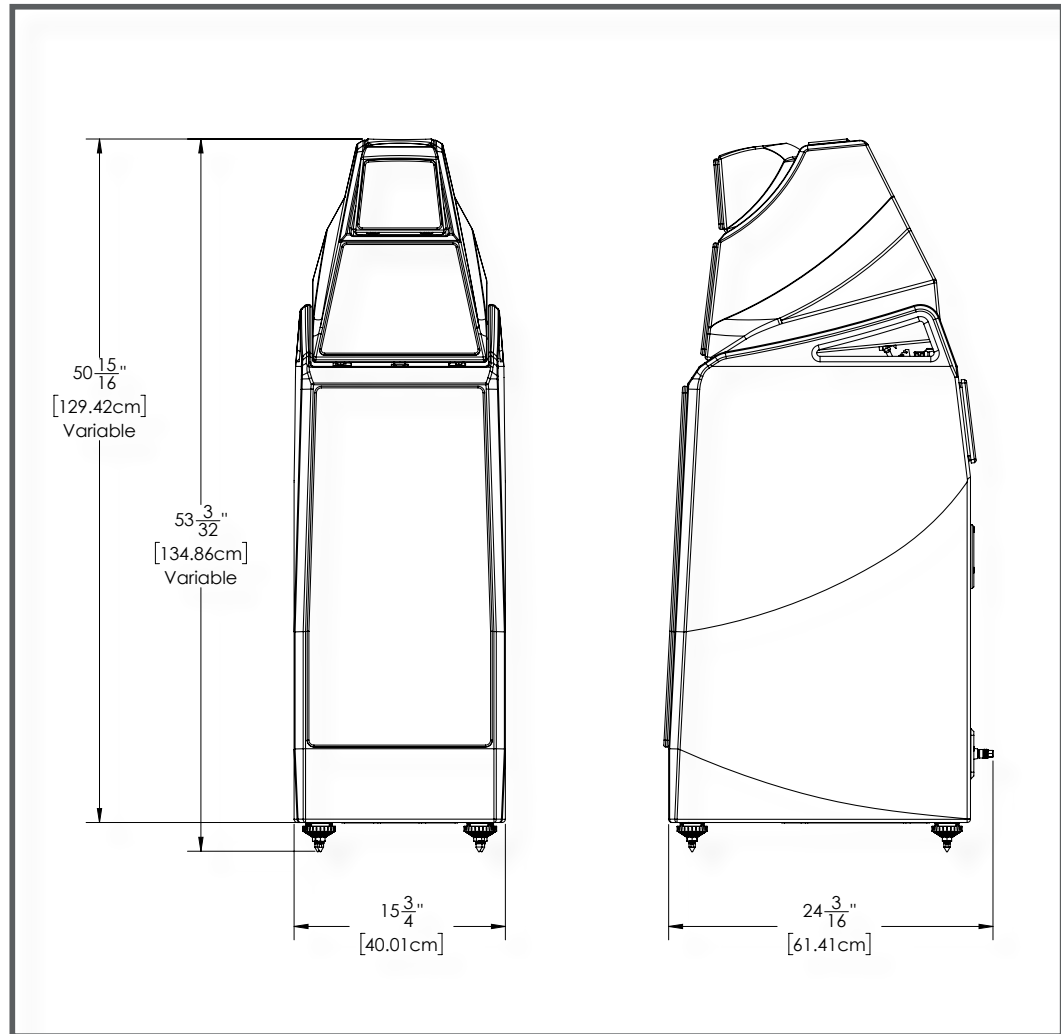

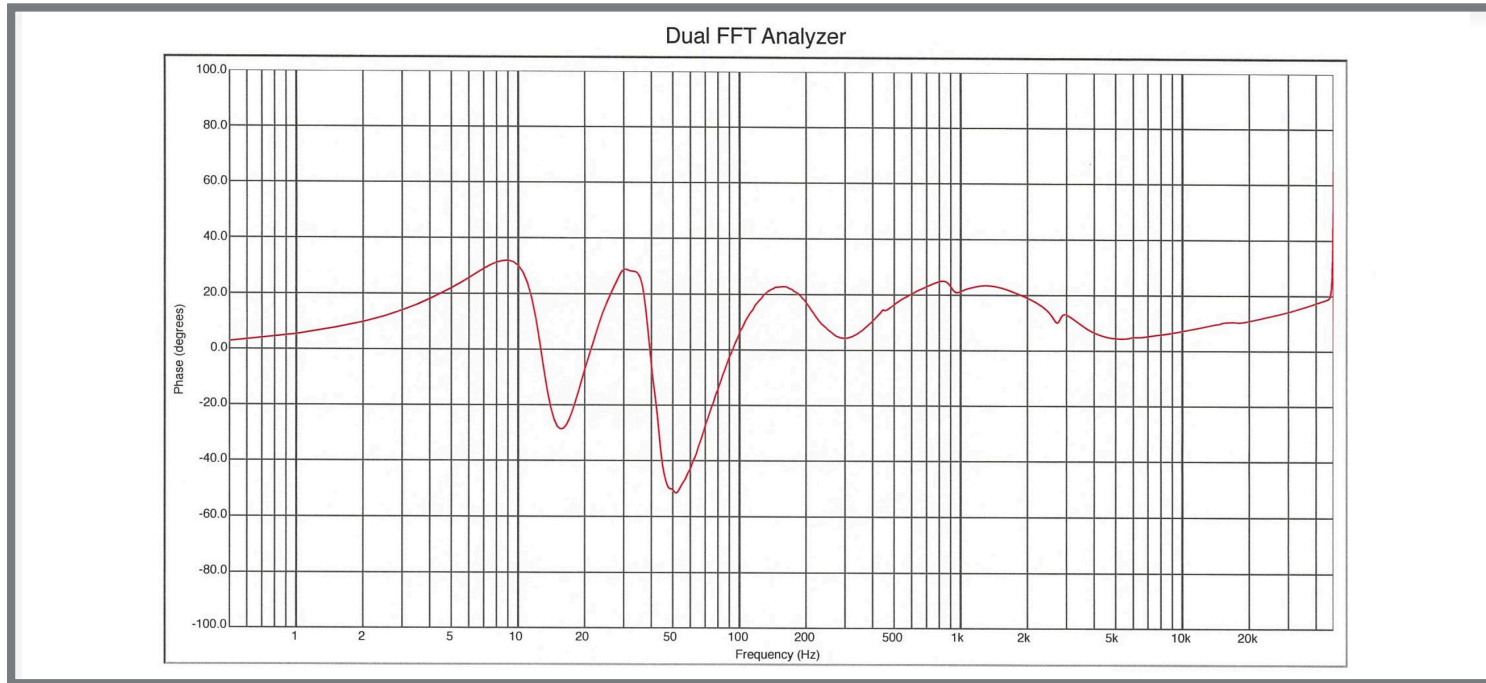

SECTION 5.3—ALEXIA V PHASE CURVE

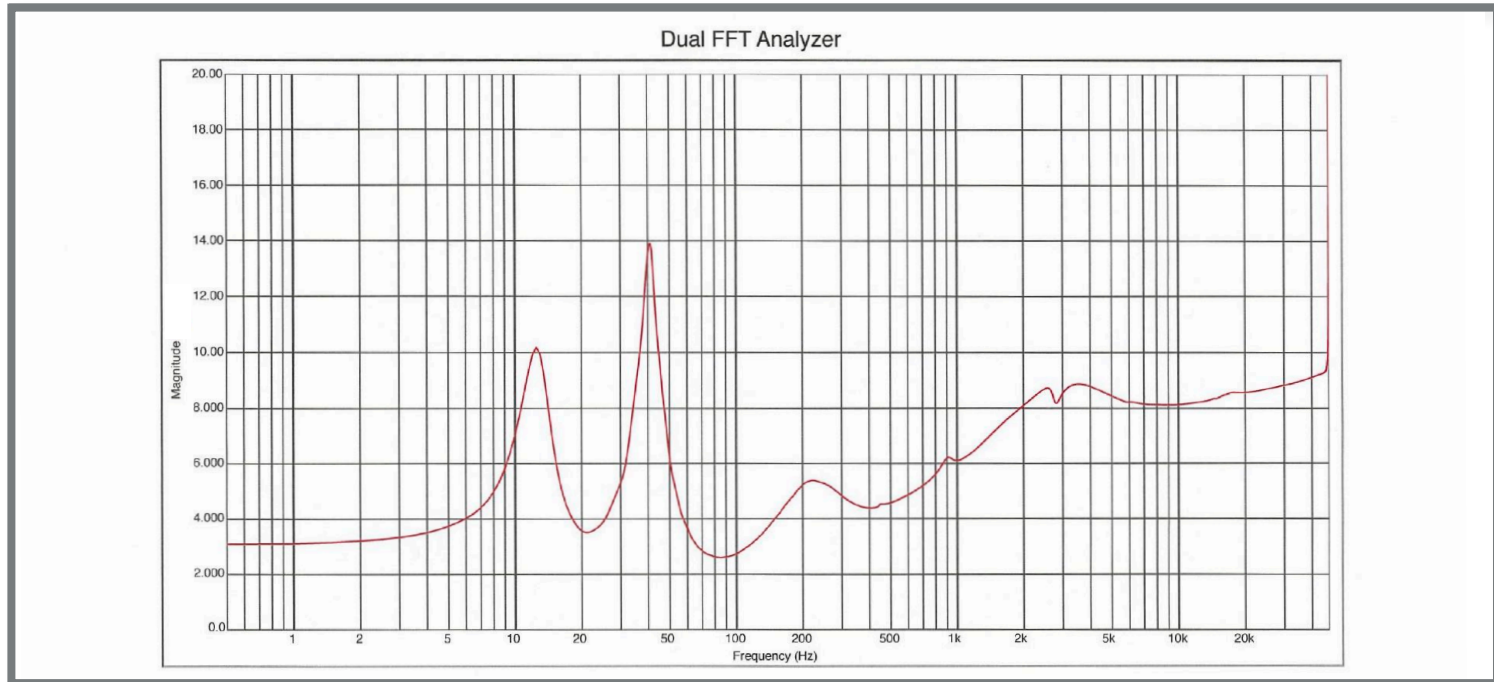

SECTION 5.4—ALEXIA V IMPEDANCE CURVE



SECTION 6—TIME ALIGNMENT CHARTS

Upper Array Alignment Block Position

Listening Distance

Ear Height		8 ft	8.5 ft	9 ft	9.5 ft	10 ft	10.5 ft	11 ft	11.5 ft	12 ft	13 ft	14 ft	16 ft	18 ft	20 ft
		2.44 m	2.59 m	2.74 m	2.9 m	3.05 m	3.2 m	3.35 m	3.51 m	3.66 m	3.96 m	4.27 m	4.88 m	5.49 m	6.1 m
48 in	122 cm	*	*	*	*	*	*	1	2	2.5	3	4	5.5	7	8
46 in	117 cm	*	*	1	1	2	3	3.5	4.5	5	6	6	8	9	10
44 in	112 cm	3	4.5	4.5	5	6	7	6.5	7	7.5	8.5	9.5	10	11	12
42 in	106.5 cm	*	1.5	2	2	3	9.5	10	11	10	11	12	12	13	13
40 in	101.5 cm	4.5	5.5	5	6	5.5	6	7	13.5	14	13.5	14.5	14.5	15.5	15
38 in	96.5 cm	9	8.5	9.5	9	9.5	10	9.5	10	10.5	10	17	16.5	16.5	17
36 in	91.5 cm	13	13	13.5	13	12.5	13	12	12.5	13	12.5	13	19	18.5	19

Upper Array Alignment Block Step

Listening Distance

Ear Height		8 ft	8.5 ft	9 ft	9.5 ft	10 ft	10.5 ft	11 ft	11.5 ft	12 ft	13 ft	14 ft	16 ft	18 ft	20 ft
		2.44 m	2.59 m	2.74 m	2.9 m	3.05 m	3.2 m	3.35 m	3.51 m	3.66 m	3.96 m	4.27 m	4.88 m	5.49 m	6.1 m
48 in	122 cm	*	*	*	5	5	5	5	5	5	4	4	4	4	4
46 in	117 cm	7	7	7	6	6	6	6	6	6	6	5	5	5	5
44 in	112 cm	9	9	8	8	8	8	7	7	7	7	7	6	6	6
42 in	106.5 cm	2	2	2	1	1	9	9	9	8	8	8	7	7	6
40 in	101.5 cm	4	4	3	3	2	2	2	10	10	9	9	8	8	7
38 in	96.5 cm	6	5	5	4	4	4	3	3	3	2	10	9	8	8
36 in	91.5 cm	8	7	7	6	5	5	4	4	4	3	3	10	9	9

Midrange Spike Length

Listening Distance

Ear Height		8 ft	8.5 ft	9 ft	9.5 ft	10 ft	10.5 ft	11 ft	11.5 ft	12 ft	13 ft	14 ft	16 ft	18 ft	20 ft
		2.44 m	2.59 m	2.74 m	2.9 m	3.05 m	3.2 m	3.35 m	3.51 m	3.66 m	3.96 m	4.27 m	4.88 m	5.49 m	6.1 m
48 in	122 cm	*	*	*	No Spike	No Spike	No Spike	No Spike	No Spike	No Spike	No Spike	No Spike	No Spike	No Spike	No Spike
46 in	117 cm	No Spike	No Spike	No Spike	No Spike	No Spike	No Spike	No Spike	No Spike	No Spike	No Spike	No Spike	No Spike	No Spike	No Spike
44 in	112 cm	No Spike	No Spike	No Spike	No Spike	No Spike	No Spike	No Spike	No Spike	No Spike	No Spike	No Spike	No Spike	No Spike	No Spike
42 in	106.5 cm	2	2	2	2	2	No Spike	No Spike	No Spike	No Spike	No Spike	No Spike	No Spike	No Spike	No Spike
40 in	101.5 cm	2	2	2	2	2	2	2	No Spike	No Spike	No Spike	No Spike	No Spike	No Spike	No Spike
38 in	96.5 cm	2	2	2	2	2	2	2	2	2	2	No Spike	No Spike	No Spike	No Spike
36 in	91.5 cm	2	2	2	2	2	2	2	2	2	2	2	No Spike	No Spike	No Spike

Tweeter Detent Position

Listening Distance

Ear Height		8 ft	8.5 ft	9 ft	9.5 ft	10 ft	10.5 ft	11 ft	11.5 ft	12 ft	13 ft	14 ft	16 ft	18 ft	20 ft
		2.44 m	2.59 m	2.74 m	2.9 m	3.05 m	3.2 m	3.35 m	3.51 m	3.66 m	3.96 m	4.27 m	4.88 m	5.49 m	6.1 m
48 in	122 cm	*	*	*	6	6	6	6	5.5	5.5	5.5	5.5	5	5	5
46 in	117 cm	6.5	6.5	6.5	6	6	6	6	5.5	5.5	5.5	5.5	5	5	5
44 in	112 cm	6.5	6.5	6.5	6	6	6	6	5.5	5.5	5.5	5.5	5	5	5
42 in	106.5 cm	6.5	6.5	6.5	6	6	6	6	5.5	5.5	5.5	5.5	5	5	5
40 in	101.5 cm	6.5	6.5	6.5	6	6	6	6	5.5	5.5	5.5	5.5	5	5	5
38 in	96.5 cm	6.5	6.5	6.5	6	6	6	6	5.5	5.5	5.5	5.5	5	5	5
36 in	91.5 cm	6.5	6.5	6.5	6	6	6	6	5.5	5.5	5.5	5.5	5	5	5

* Please contact your dealer.

*Back of alignment block lines up with back edge of alignment plate

*Back of alignment block is 1/8" from back edge of alignment plate

*Back of alignment block is 1/4" from back edge of alignment plate

*Back of alignment block is 1/16" from back edge of alignment plate

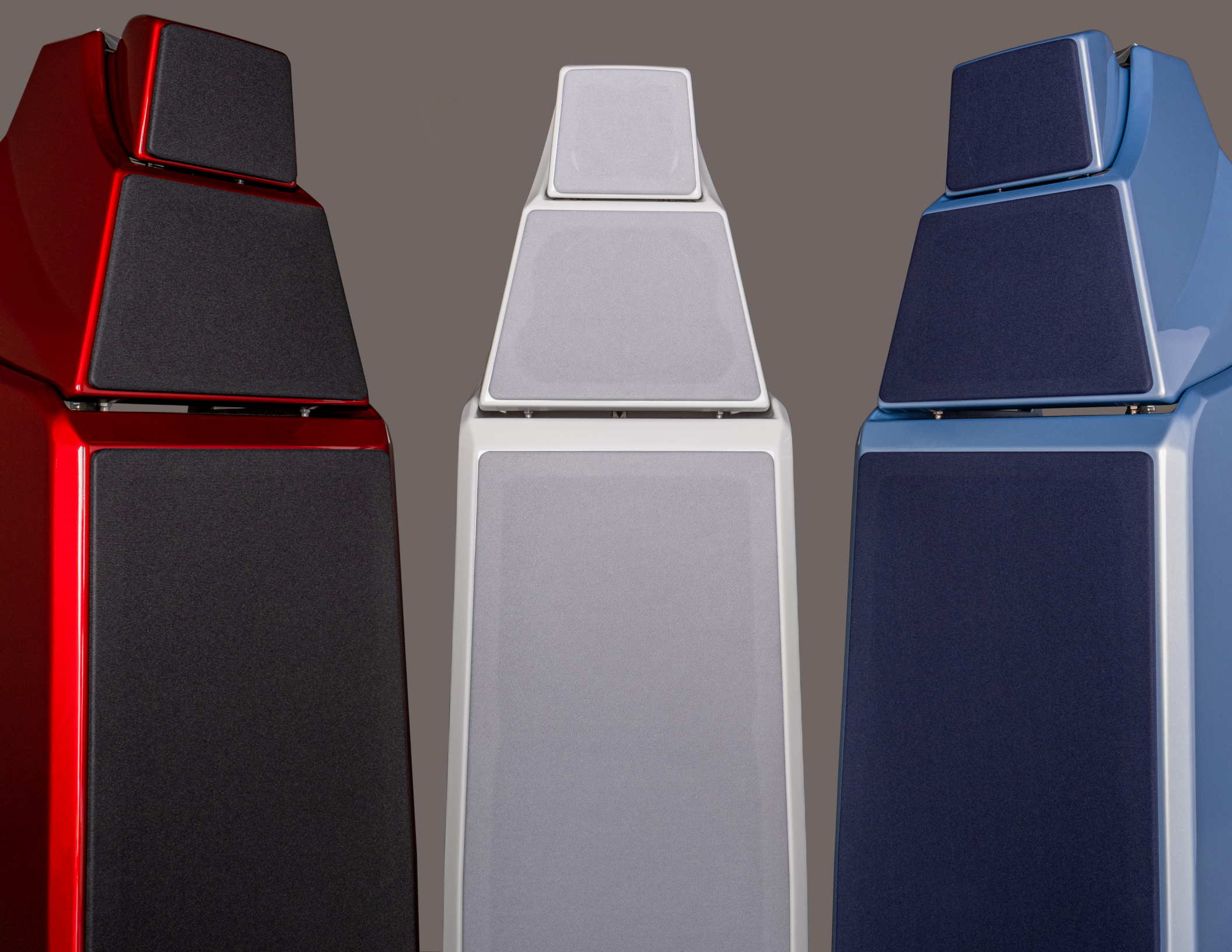

SECTION 7—WARRANTY

SECTION 7—WARRANTY DETAILS

Limited Warranty

Subject to the conditions set forth herein, Wilson Audio warrants its electronics to be free of manufacturing defects in material and workmanship for the Warranty Period. The Warranty Period is a period of 90 days from the date of purchase by the original purchaser, or if both of the following two requirements are met, the Warranty Period is a period of five (5) years from the date of purchase by the original purchaser:

Requirement No. 1. No later than 30 days after product delivery to the customer, the customer must have returned the Warranty Registration Form to Wilson Audio. Alternatively, the warranty may be filled out on Wilson Audio's website.

Requirement No. 2. The product must have been professionally installed by the Wilson Audio Dealer that sold the product to the customer.

FAILURE TO COMPLY WITH EITHER REQUIREMENT NO. 1 OR REQUIREMENT NO. 2 WILL RESULT IN THE WARRANTY PERIOD BEING LIMITED TO A PERIOD OF 90 DAYS ONLY.

Conditions

This Limited Warranty is also subject to the following conditions and limitations. The Limited Warranty is void and inapplicable if the product has been used or handled other than in accordance with the instructions in the owner's manual, or has been abused or misused, damaged by accident or neglect or in being transported, or if the product has been tampered with or service or repair of the product has been attempted or performed by anyone other than Wilson Audio, an authorized Wilson Audio Dealer Technician or a service or repair center authorized by Wilson Audio to service or repair the product. Contact Wilson Audio at 1(801) 377-2233 for information on location of Wilson Audio Dealers and authorized service and repair centers. Most repairs can be made in the field. In instances where return to Wilson Audio's factory is required, the Dealer or customer must first obtain a return authorization. Purchaser must pay for shipping to Wilson Audio, and Wilson Audio will pay for shipping of its choice to return the product to purchaser. A RETURNED PRODUCT MUST BE ACCOMPANIED BY A WRITTEN DESCRIPTION OF THE DEFECT. Wilson Audio reserves the right to modify the design of any product without obligation to purchasers of previously manufactured products and to change the prices or specifications of any product without notice or obligation to any person.

Remedy

In the event that the product fails to meet the above Limited Warranty and the conditions set forth herein have been met, the purchaser's sole remedy under this Limited Warranty shall be to: (1) contact an authorized Wilson Audio Dealer within the Warranty Period for service or repair of the product without charge for parts or labor, which service or repair, at the Dealer's option, shall take place either at the location where the product is installed or at the Dealer's place of business; or (2) if purchaser has timely sought service or repair and the product cannot be serviced or repaired by the Dealer, then purchaser may obtain a return authorization from Wilson Audio and at purchaser's expense return the product to Wilson Audio where the defect will be rectified without charge for parts or labor.

Warranty Limited to Original Purchaser

This Limited Warranty is for the sole benefit of the original purchaser of the covered product and shall not be transferred to a subsequent purchaser of the product, unless the product is purchased by the subsequent purchaser from an authorized Wilson Audio Dealer who has certified the product in accordance with Wilson Audio standards and requirements and the certification has been accepted by Wilson Audio, in which event the Limited Warranty for the product so purchased and certified shall expire at the end of the original Warranty Period applicable to the product.

Demonstration Equipment

Equipment, while used by an authorized Dealer for demonstration purposes, is warranted to be free of manufacturing defects in materials and workmanship for a period of five (5) years from the date of shipment to the Dealer. Demo equipment needing warranty service may be repaired on-site or, if necessary, correctly packed and returned to Wilson Audio by the Dealer at Dealer's sole expense. Wilson Audio will pay return freight of its choice. A returned product must be accompanied by a written description of the defect. Dealer owned demonstration equipment sold at retail within two (2) years of date of shipment to the Dealer is warranted to the first retail customer to be free of manufacturing defects in materials and workmanship for the same time periods as if the product had originally been bought for immediate resale to the retail customer. Wilson Audio products are warranted for a period of 90 days, unless extended to 5 years, as provided above, by return and filing of completed Warranty Registration at Wilson Audio within 30 days after product delivery to customer and the product was professionally installed by the Wilson Audio Dealer that sold the product to the customer.

Miscellaneous

ALL EXPRESS AND IMPLIED WARRANTIES NOT PROVIDED FOR HEREIN ARE HEREBY EXPRESSLY DISCLAIMED. ANY LEGALLY IMPOSED IMPLIED WARRANTIES RELATING TO THE PRODUCT SHALL BE LIMITED TO THE DURATION OF THIS LIMITED WARRANTY. THIS LIMITED WARRANTY DOES NOT EXTEND TO ANY INCIDENTAL OR CONSEQUENTIAL COSTS OR DAMAGES TO THE PURCHASER.

Some states do not allow limitations on how long an implied warranty lasts or an exclusion or limitation of incidental or consequential damages, so the above limitations or exclusions may not apply to you. This Limited Warranty gives you specific legal rights, and you may also have other rights, which vary from state to state.



- Replacement Resistors
- Books and Literature
- Custom Loudspeaker Covers
- Installation Tools and Accessories
- New Grilles and Diffraction Blankets
- WilsonGloss® Care Products and Kits
- Wilson Signature Apparel
- Upgrade Spikes and Binding Posts
- ... And More

Visit our Service Channel on YouTube to view How-To videos



PARTS STORE



SERVICE CHANNEL